

6" FRAME

TF-150 F6

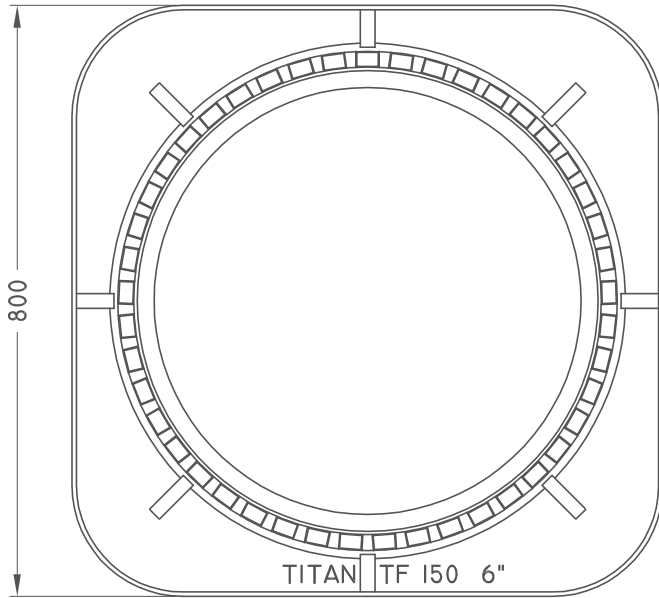

PLAN

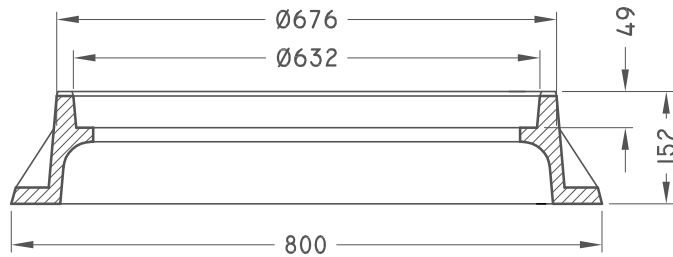
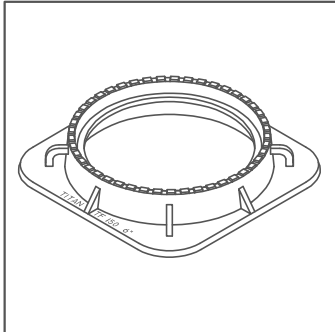

SECTION

ISO 9001-2000 CERTIFIED

RATED FOR HS-20 LIVE LOAD

MEASUREMENTS IN MILLIMETERS



1350 FIFE STREET
WINNIPEG, MB
R2X 2N7
(P) 204.633.5535
(F) 204.694.2210