

# 6" FRAME

TF-101 F6

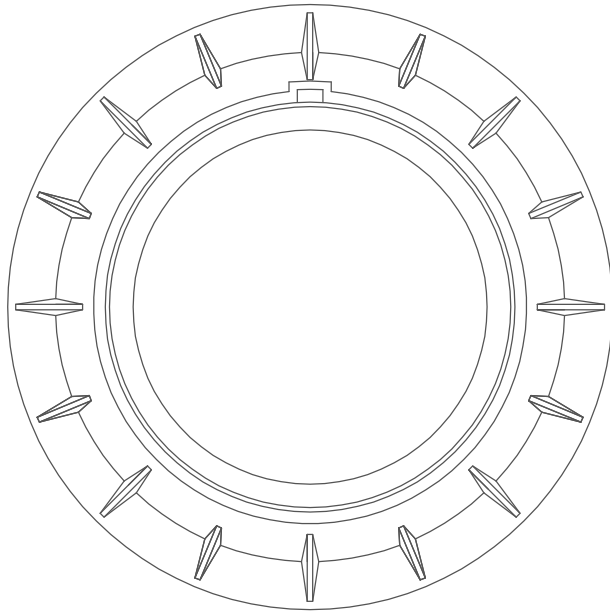

PLAN

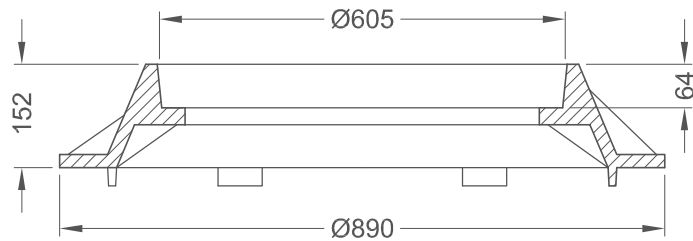
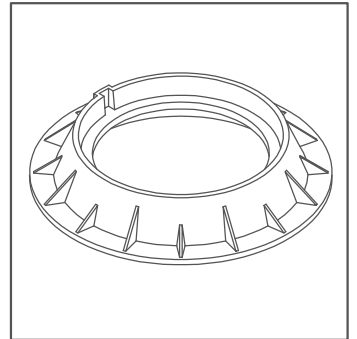

SECTION

ISO 9001-2000 CERTIFIED

RATED FOR HS-20 LIVE LOAD

MEASUREMENTS IN MILLIMETERS



1350 FIFE STREET  
WINNIPEG, MB  
R2X 2N7  
(P) 204.633.5535  
(F) 204.694.2210